

Subject to change. | Änderungen vorbehalten.

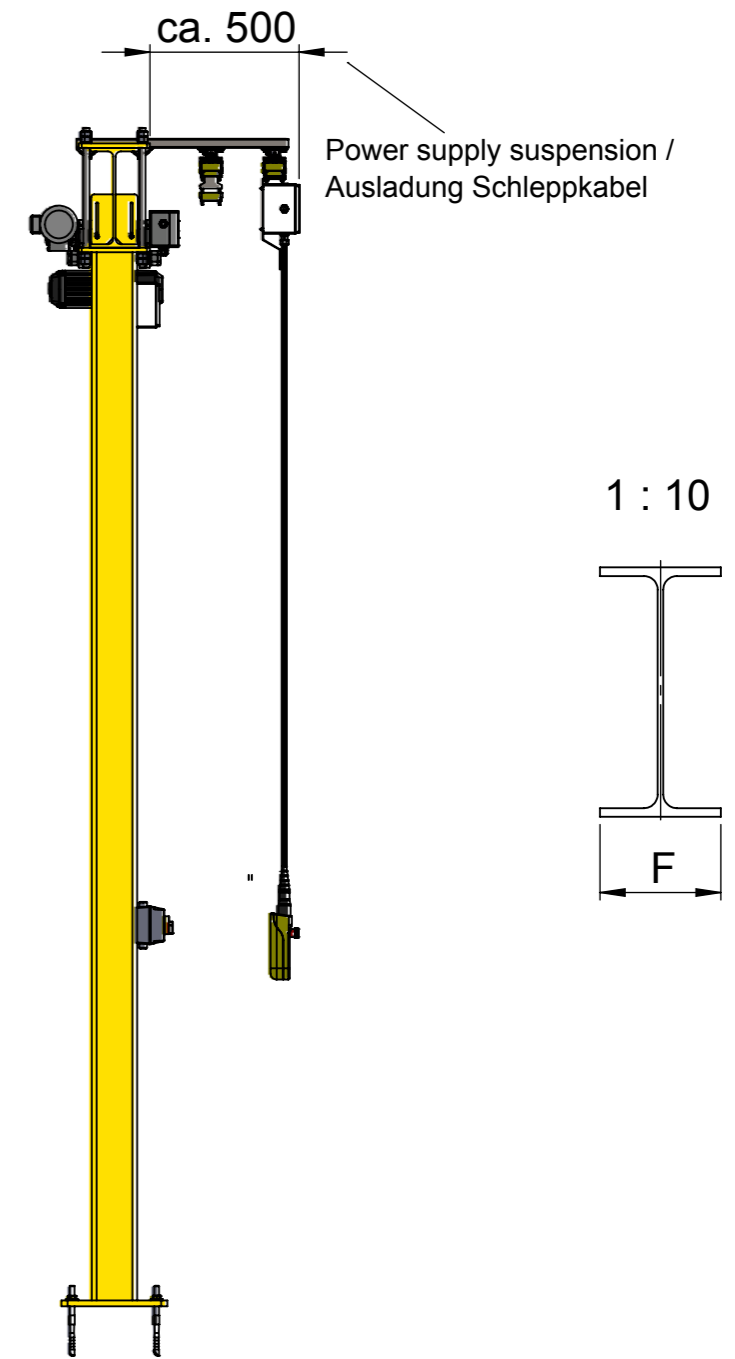
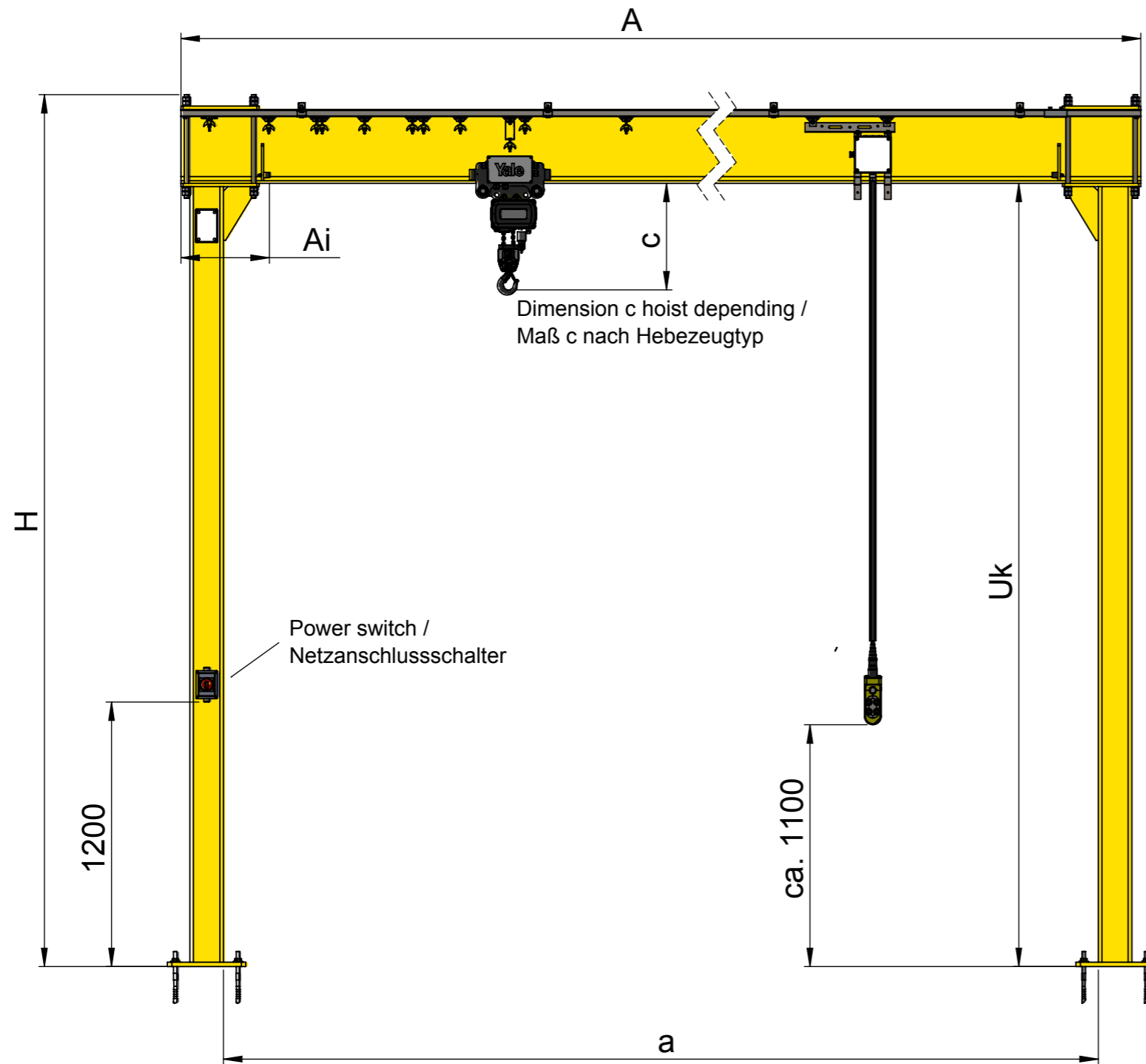

Technical data / Technischen Daten

Capacity / Tragfähigkeit		500	[kg]
Total width / Gesamtbreite	A =	4380	[mm]
Overall height / Gesamthöhe	H =	3897	[mm]
Horizontal clearance / Lichte Weite	a =	4000	[mm]
Beam clearance / Lichte Höhe (Unterkante Träger)	Uk =	3500	[mm]
Dead zone (Buffer) / Anfahrmaß (Puffer)	Ai =	396	[mm]
Flange width / Trägerflanschbreite	F =	160	[mm]

Hoist only for visualization purposes. / Elektrokettenzug nur für Ansichtszwecke.

		Part name				Quantity:	
		0043.19 CMCO-100_050 Setup				1	
		Drawing nr				Weight:	
		CMCO-100_050_35_40				527 kg	
Dimension in	Sheet	Size	Scale	Index	Date	Version	
mm	1 / 2	A3		PW	2019-04-09	1.0	
<small>General tolerances for nominal dimension without specified tolerance: IT 13 The Information Contained In This Drawing Is The Sole Property Of Columbus Mckinnon Corporation. Any Reproduction In Part Or As A Whole Without The Written Permission Of Columbus Mckinnon Corporation Is Prohibited.</small>							

Subject to change. | Änderungen vorbehalten.

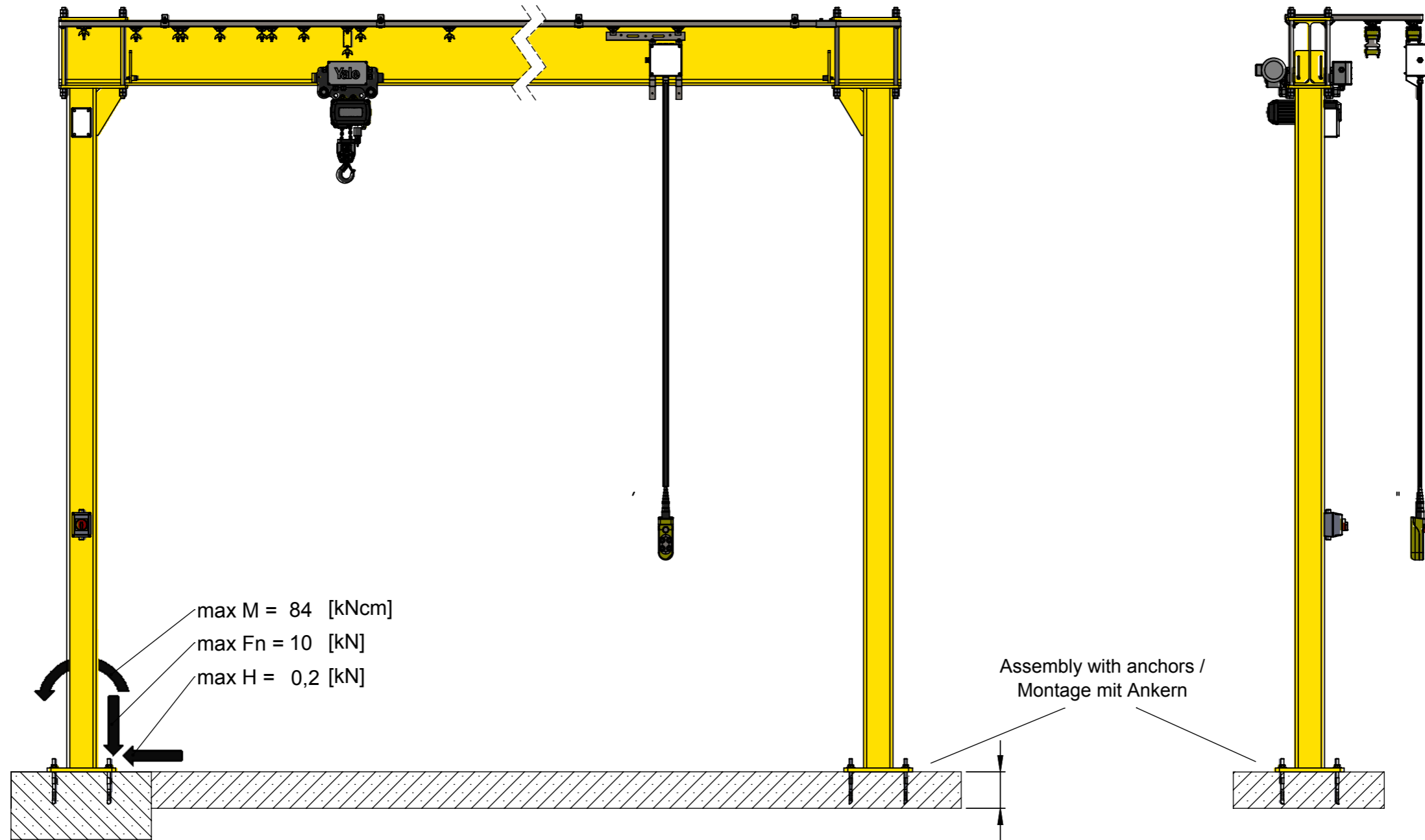

max M = 84 [kNcm]
 max Fn = 10 [kN]
 max H = 0,2 [kN]

Assembly with anchors /
 Montage mit Ankern

Flooring < 200, a plinth should be made /
 Bei Schichtdicke < 200, Betonsockel notw.

Thickness min. 200, min. C20/25 /
 Betondicke min. 200, min. C20/25

Max. foot pressure on the foundation 18 [N/cm²] /
 Max. Bodenpressung in der Trennfuge Fundament/Erdreich 18 [N/cm²]

Basic information / Informationen

Performance and classification. / Leistung und Klassifizierung. DIN EN 13001 HC2 / S2

Design and production / Design und Fertigung Columbus McKinnon Polska

Total mass / Gesamtgewicht 527 [kg]

Max. weight hoist / Max. Gewicht des Hebezeugs 80 [kg]

Max. lifting speed / Max. Hubgeschwindigkeit 8 [m/min]

Max. hoist speed / Max. Fahrgeschwindigkeit 25 [m/min]

Required power / Motorleistung 2 [kW]

Power supply / Stromversorgung 3x400 ; 50 [V] ; [Hz]

Class of protection / Schutzklasse IP54

Color / Farbe RAL 1003

Manual or electrical hoist not within scope of delivery / Handhebezeug bzw. E-Kettenzug nicht Bestandteil der Lieferung.

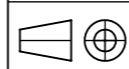
		Part name				Quantity:	
		0043.19 CMCO-100_050 Setup				1	
		Drawing nr				Weight:	
		CMCO-100_050_35_40				527 kg	
Dimension in	Sheet	Size	Scale	Index	Date	Version	
mm	2 / 2	A3		PW	2019-04-09	1.0	
General tolerances for nominal dimension without specified tolerance: IT 13 The Information Contained In This Drawing Is The Sole Property Of Columbus McKinnon Corporation. Any Reproduction In Part Or As A Whole Without The Written Permission Of Columbus McKinnon Corporation Is Prohibited.							